

dinkey CC



Constant current version of Dinkey

Installation with standardized cables and connectors.

Available for mounting on LED profile system.

Optics (lenses) can be interchanged without tools.

Description

Dinkey is widely used inside larger display cases in museums.

It's also the perfect fixture for smaller art galleries, in cafes, corridors or home environment.

TECHNICAL SPECIFICATION

Material	Lamp housing of die-cast magnesium Yoke and details of steel Adapter of aluminum Lens of PC
Finish	Grey (RAL 9006) Black (RAL 9005) White (RAL 9016)
System	LED profile Surface mounting
Dimming control	Via external driver
Protection class	IP20
Power consumption	3W/6W
CRI	90
Color temperature	2700K/3000K/4000K
Beam angle	Plain tight, Frosted Narrow, Frosted Medium, Frosted Wide, Elliptical
Swivels	>365°
Tilts	>90°
Optional accessories	Filters and honeycombs

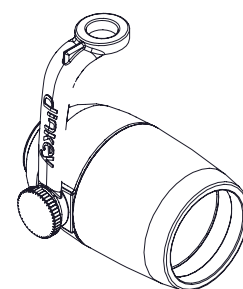
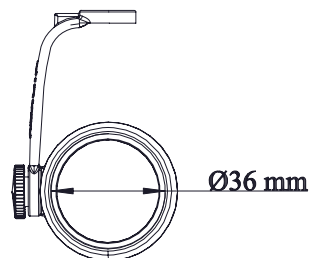
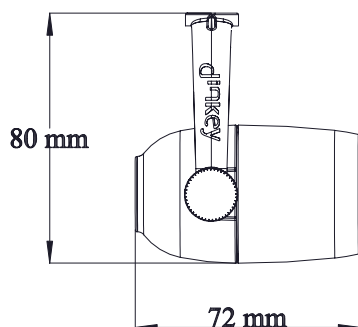









DINKEY CC 250LM LED PROFILE

Installation on LED profile High or Low. Max 1050mA, 3W.

2700K		DIN27-CCL-1	Dinkey CC/1050mA LED profile 2700K, Grey	250lm, Vf=3V, 1050mA, CRI90, Lens N
		DIN27-CCL-2	Dinkey CC/1050mA LED profile 2700K, Black	250lm, Vf=3V, 1050mA, CRI90, Lens N
		DIN27-CCL-3	Dinkey CC/1050mA LED profile 2700K, White	250lm, Vf=3V, 1050mA, CRI90, Lens N
3000K		DIN30-CCL-1	Dinkey CC/1050mA LED profile 3000K, Grey	260lm, Vf=3V, 1050mA, CRI90, Lens N
		DIN30-CCL-2	Dinkey CC/1050mA LED profile 3000K, Black	260lm, Vf=3V, 1050mA, CRI90, Lens N
		DIN30-CCL-3	Dinkey CC/1050mA LED profile 3000K, White	260lm, Vf=3V, 1050mA, CRI90, Lens N
4000K		DIN40-CCL-1	Dinkey CC/1050mA LED profile 4000K, Grey	260lm, Vf=3V, 1050mA, CRI90, Lens N
		DIN40-CCL-2	Dinkey CC/1050mA LED profile 4000K, Black	260lm, Vf=3V, 1050mA, CRI90, Lens N
		DIN40-CCL-3	Dinkey CC/1050mA LED profile 4000K, White	260lm, Vf=3V, 1050mA, CRI90, Lens N

DINKEY CC 250LM SOLO

Surface mounting. Max 1050mA, 3W.

2700K		DIN27-CCS-1	Dinkey CC/1050mA Solo 2700K, Grey	250lm, Vf=3V, 1050mA, CRI90, Lens N, 1m cable
		DIN27-CCS-2	Dinkey CC/1050mA Solo 2700K, Black	250lm, Vf=3V, 1050mA, CRI90, Lens N, 1m cable
		DIN27-CCS-3	Dinkey CC/1050mA Solo 2700K, White	250lm, Vf=3V, 1050mA, CRI90, Lens N, 1m cable
3000K		DIN30-CCS-1	Dinkey CC/1050mA Solo 3000K, Grey	260lm, Vf=3V, 1050mA, CRI90, Lens N, 1m cable
		DIN30-CCS-2	Dinkey CC/1050mA Solo 3000K, Black	260lm, Vf=3V, 1050mA, CRI90, Lens N, 1m cable
		DIN30-CCS-3	Dinkey CC/1050mA Solo 3000K, White	260lm, Vf=3V, 1050mA, CRI90, Lens N, 1m cable
4000K		DIN40-CCS-1	Dinkey CC/1050mA Solo 4000K, Grey	260lm, Vf=3V, 1050mA, CRI90, Lens N, 1m cable
		DIN40-CCS-2	Dinkey CC/1050mA Solo 4000K, Black	260lm, Vf=3V, 1050mA, CRI90, Lens N, 1m cable
		DIN40-CCS-3	Dinkey CC/1050mA Solo 4000K, White	260lm, Vf=3V, 1050mA, CRI90, Lens N, 1m cable







DINKEY CC 450LM LED PROFILE

Installation on LED profile High or Low. Max 500mA, 6W.

2700K		DIN27B-CCL-1	Dinkey CC/500mA LED profile 2700K, Grey	450lm, Vf=12V, 500mA, CRI90, Lens N
		DIN27B-CCL-2	Dinkey CC/500mA LED profile 2700K, Black	450lm, Vf=12V, 500mA, CRI90, Lens N
		DIN27B-CCL-3	Dinkey CC/500mA LED profile 2700K, White	450lm, Vf=12V, 500mA, CRI90, Lens N
3000K		DIN30B-CCL-1	Dinkey CC/500mA LED profile 3000K, Grey	480lm, Vf=12V, 500mA, CRI90, Lens N
		DIN30B-CCL-2	Dinkey CC/500mA LED profile 3000K, Black	480lm, Vf=12V, 500mA, CRI90, Lens N
		DIN30B-CCL-3	Dinkey CC/500mA LED profile 3000K, White	480lm, Vf=12V, 500mA, CRI90, Lens N

DINKEY CC 450LM SOLO

Surface mounting. Max 500mA, 6W.

2700K		DIN27B-CCS-1	Dinkey CC/500mA Solo 2700K, Grey	450lm, Vf=12V, 500mA, CRI90, Lens N, 1m cable
		DIN27B-CCS-2	Dinkey CC/500mA Solo 2700K, Black	450lm, Vf=12V, 500mA, CRI90, Lens N, 1m cable
		DIN27B-CCS-3	Dinkey CC/500mA Solo 2700K, White	450lm, Vf=12V, 500mA, CRI90, Lens N, 1m cable
3000K		DIN30B-CCS-1	Dinkey CC/500mA Solo 3000K, Grey	480lm, Vf=12V, 500mA, CRI90, Lens N, 1m cable
		DIN30B-CCS-2	Dinkey CC/500mA Solo 3000K, Black	480lm, Vf=12V, 500mA, CRI90, Lens N, 1m cable
		DIN30B-CCS-3	Dinkey CC/500mA Solo 3000K, White	480lm, Vf=12V, 500mA, CRI90, Lens N, 1m cable